

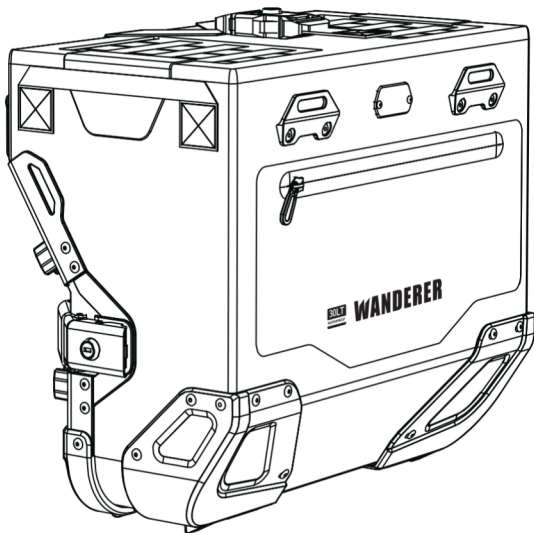

# Side Bag User Manual

Model: BCB30TBK



Please read the manual and related after-sales service terms carefully before use. Incorrect installation and use can damage the product, significantly affect safe driving, and lose related free warranty services.



Scan QR Code To Watch  
The Installation Video

## Parameter

Model: BCB30TBK

Bag Material: TPU, 840D Nylon Fabric, Hypalon

Inner Bag Material: TPU, 840D Nylon Fabric













Side Bag Mounting Plate Material: Aluminum Alloy, Nylon, Silicone





Dimensions: Length 450mm/17.72in \* Width 270mm/10.63in \*

Height 400mm/15.75in

Compatible Side Racks: LOBOO PIKE TRACKER Series, LOBOO TIBET-B Series

## Accessories List

NO.	Name	Diagram	Quantity	Remarks
①	Side Bag		1pc	Right Side Bag
②	Multipurpose Waterproof Bag		1pc	
③	U-shaped PP Support Plate		1pc	
④	Side PP Support Plate		1pc	
⑤	Hex Wrench		1pc	
⑥	Short Tongue Lock Core		1pc	
⑦	32mm Tongue Lock Core		1pc	
⑧	Lock Core C-clip		2pcs	
⑨	Key		1pc	
⑩	Decorative Cover		1pc	
⑪	LOBOO Quick Release Strap		2pcs	
⑫	TB28 Fixed Clamp Gasket A		2pcs	
⑬	TB28 Fixed Clamp Gasket B		2pcs	

NO.	Name	Diagram	Quantity	Remarks
⑭	M5*30 Hex Countersunk Screw		2pcs	Torque: 8N·m
⑮	M5*35 Hex Countersunk Screw		6pcs	Torque: 8N·m
⑯	M5*25 Pan Head Screw		6pcs	Torque: 8N·m
⑰	M5*30 Pan Head Screw		2pcs	Torque: 8N·m

## Product Details

### Side Bag

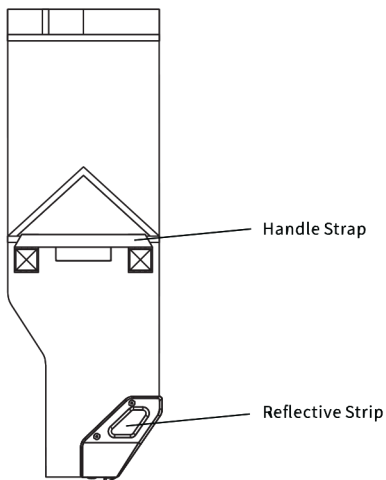

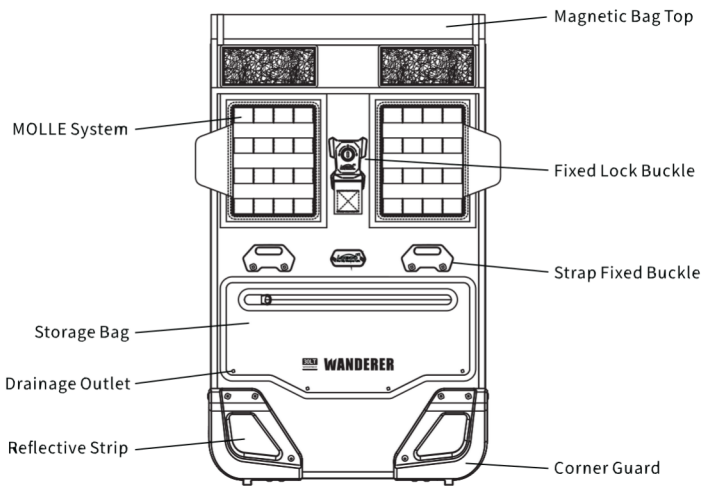

MOLLE System



Fixed Buckle

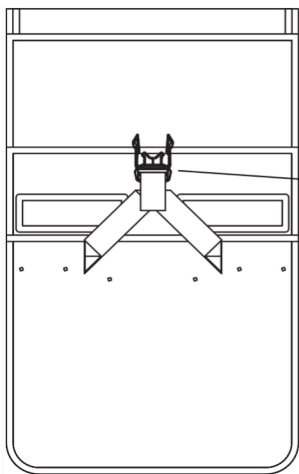

## Side Bag Mounting Plate

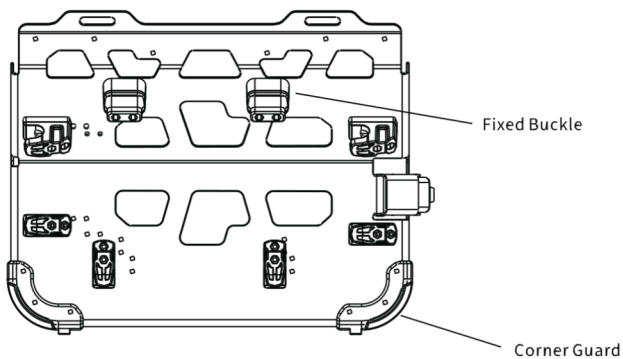
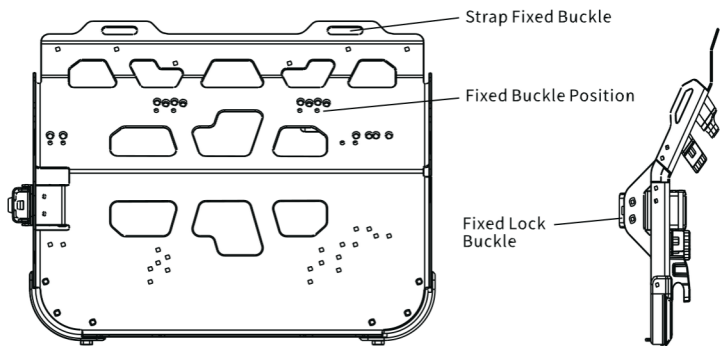

# Multipurpose Waterproof Bag

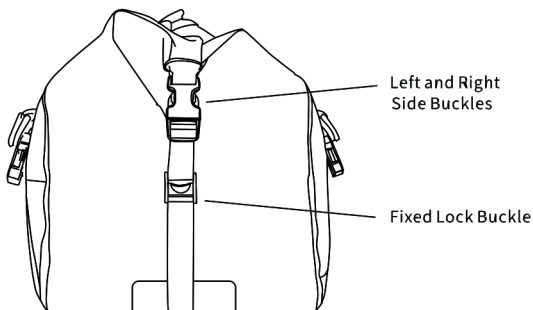
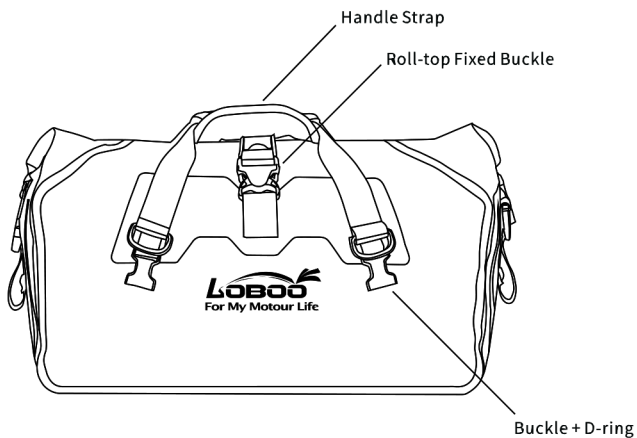

## Lock Core Installation

### 1. Top Lock Core

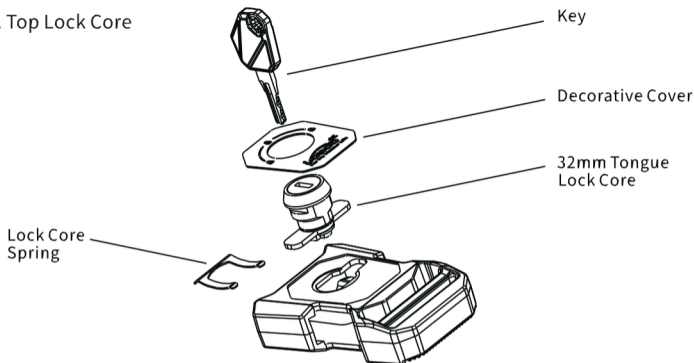

Note: Pay attention to the direction of the lock core



1. Install the 32mm tongue lock core into the fixed lock buckle.

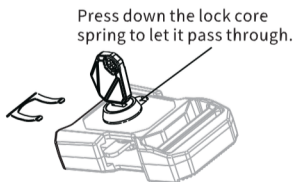

2. Insert the lock core spring to fix the lock core. (Pay attention to the direction of the spring).

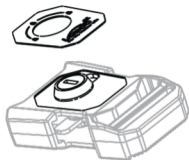

3. Pull out the lock core key, tear off the adhesive sticker at the bottom of the Decorative Cover, and stick the buckle nameplate on the fixed lock buckle.

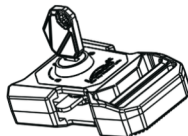

4. Installation is complete.



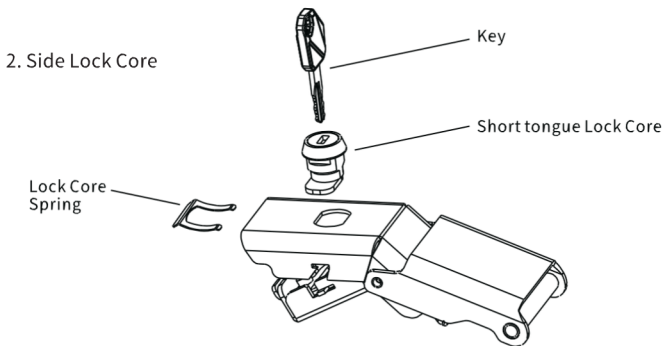

Note: Pay attention to the direction of the lock core

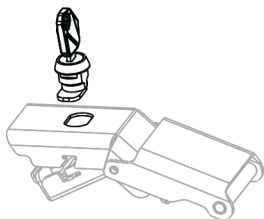

1. Install the short tongue lock core into the lock buckle.

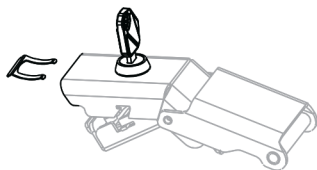

2. Insert the lock core spring to fix the lock core. (Pay attention to the direction of the spring).

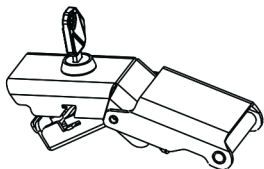

3. Installation is complete.

## Installation 1

1. Remove the U-shaped PP support plate and the side PP support plate, and remove the bottom fixed buckle.

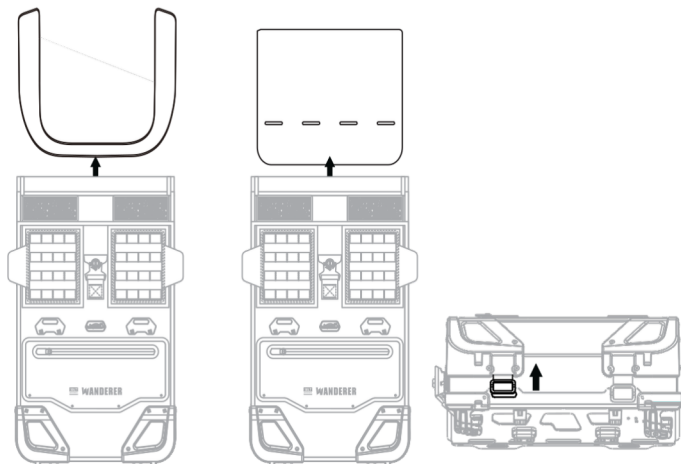

2. Lift the entire bag body upwards, adjust the position of the corresponding fixed point according to the determined side frame series.

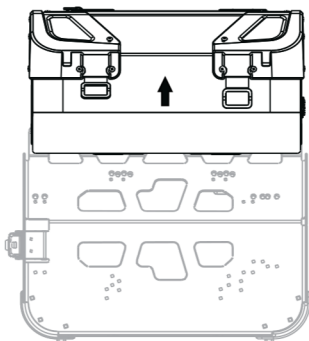

Measure the inner diameter length and height of the motorcycle side frame, compare with the figure below, and determine which series the motorcycle side rack it is:

(1) LOBOO PIKE TRACKER Series P45+P38 Installation Position

(Note: LOBOO PIKE TRACKER series P45+P38 The initial fixed point of the side bag can be installed directly. Screw torque:  $8N \cdot m$ )

Right side frame: P38 size

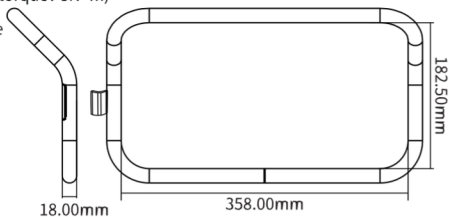

Inside of mounting plate

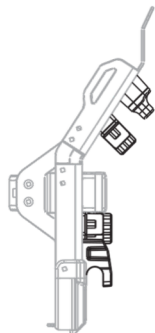
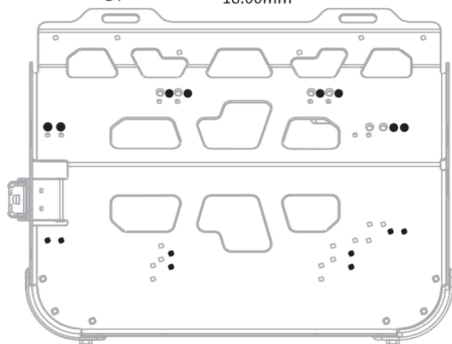

Outside of mounting plate

P38 Fixed Clamp  
Gasket B

P38 Fixed Clamp  
Gasket A

P38 Fixed Clamp  
Gasket B

P38 Fixed Clamp  
Gasket A

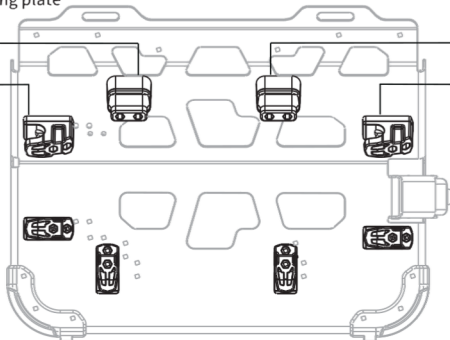

## (2) LOBOO PIKE TRACKER series P35+P30 Installation Position

(Note: Screw torque:  $8N \cdot m$ )

Right side frame: P30 size

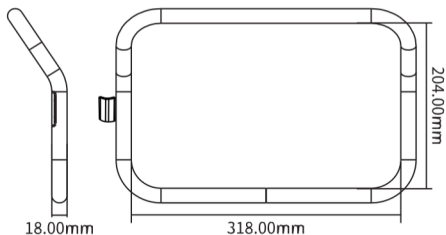

Inside of mounting plate

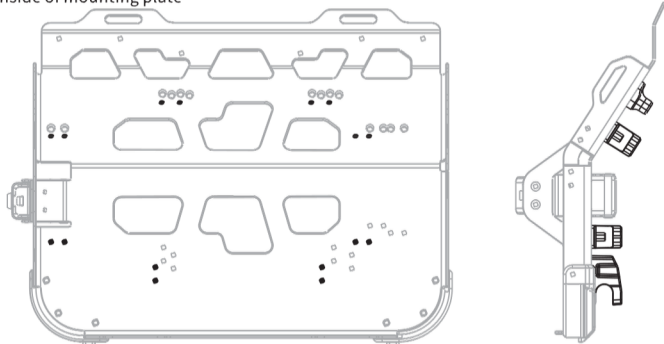

Outside of mounting plate

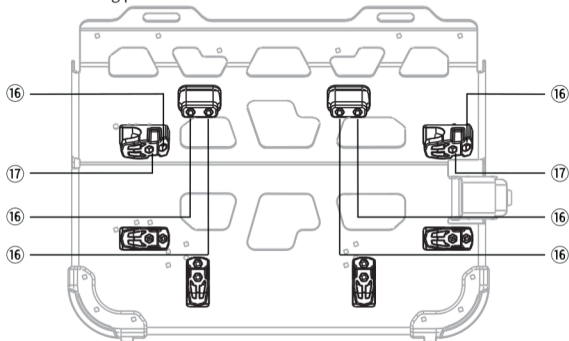

### (3) LOBOO TIBET-B series model TB35+TB28 Installation Position

(Note: Screw torque:  $8\text{N}\cdot\text{m}$ )

Right side frame: TB28 size

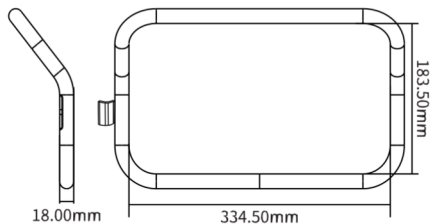

Inside of mounting plate

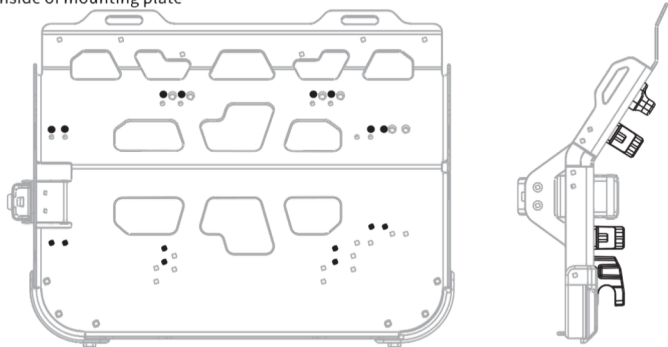

Outside of mounting plate

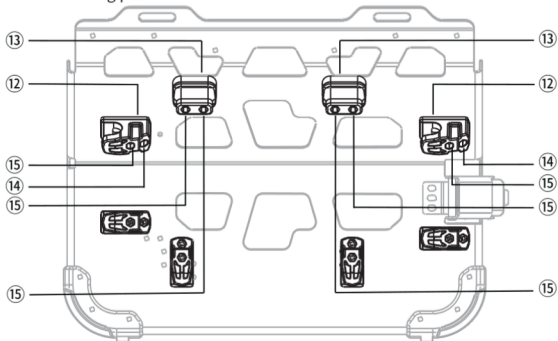

3. Fix the bottom fixed buckle, install the side PP support plate and the U-shaped PP support plate.

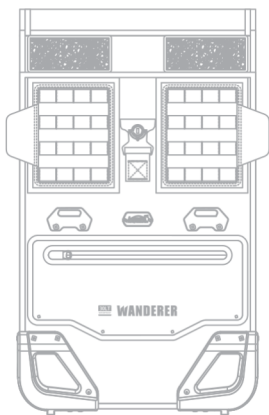
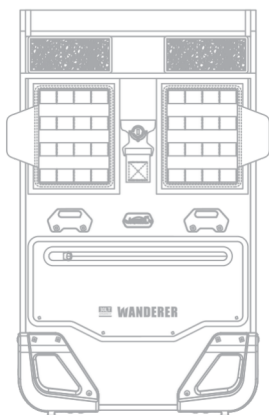
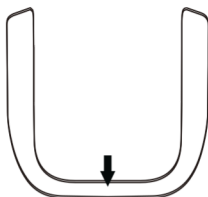
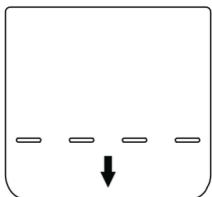
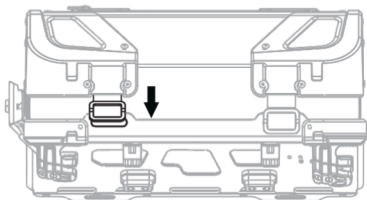

4. Fold the sides of the bag inward, bend the bag once and glue the Velcro downwards, and fasten the top buckle.

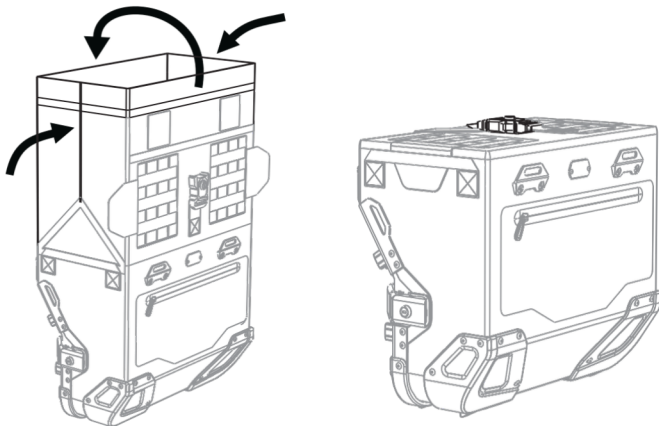

5. Fasten to the motorcycle side rack, buckle the side fixed lock buckle.

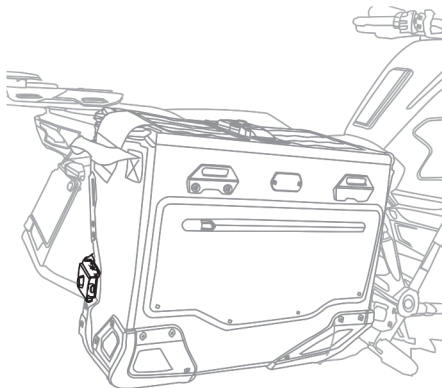

## Installation 2

### Multipurpose Waterproof Bag

1. Put the waterproof bag inside the motorcycle waterproof side bag.

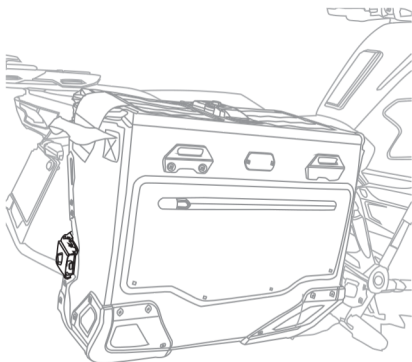
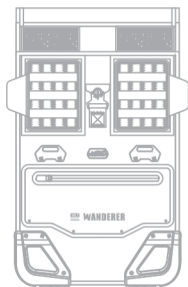

2. Fix the waterproof bag on the motorcycle waterproof side bag with a quick-release strap.

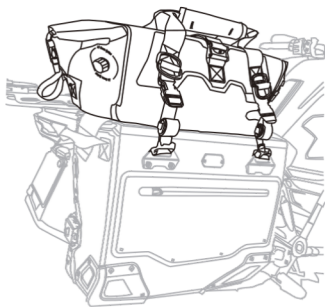
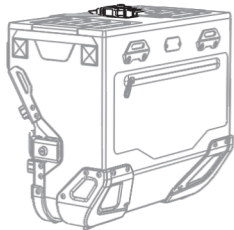



## Precautions

1. After each use, wipe off the stains on the surface of the side bag with a soft wet towel and soap (do not use bleach, fabric softener, or other acidic or alkaline cleaners). It cannot be machine washed, ironed, dry cleaned, or dried in any form. Let it dry naturally, do not expose it to the sun for a long time.
2. When not in use for a long time, the side bag should be placed in a dry and cool environment to avoid mold damage to the side bag; and regularly clean the dust and dirt on the surface of the side bag to extend its life.
3. Before going out, check that all buckles are in the locked state to avoid danger caused by the bag body falling off or opening during driving.
4. Before going out, check the handle and quick-release strap of the side bag to avoid aging affecting normal use. When using in harsh outdoor environments, do not use insect repellent on the surface of the side bag.
5. When using, please avoid sharp objects scratching the side bag fabric to avoid affecting the waterproof performance.

# Warranty Card



Please read this after-sales service guarantee card carefully. If you cannot accept it, please contact the dealer for return and exchange in time. Installation and use means acceptance of this after-sales service term.

## After-sales Service Terms

1. One-year free warranty period, this product can enjoy free repair service within one year from the date of sale if there are quality problems under normal circumstances.
2. Limited warranty: After the one-year warranty period expires, LOBOO will provide paid warranty service, the cost is based on the actual replacement material cost, and no labor cost is charged separately.

## Free warranty service does not include the following

1. No warranty card or cannot provide valid purchase proof.
2. Improper installation, use, man-made or accidental damage, self-disassembly, self-modification and repair, etc.

## Return and Exchange Information

Platform ID: \_\_\_\_\_ Order Number: \_\_\_\_\_

Contact Name: \_\_\_\_\_ Contact Phone: \_\_\_\_\_

Return Address: \_\_\_\_\_

## Discription

Please keep this card properly and send it back with the product (copy is valid)